

Supa Slat Insulated/Non-Insulated

Aluminium Roller Shutters



With its strong and robust design, the aluminium Supa Slat roller shutter is ideal for external applications and large internal openings such as wall dividers, shopping centres, arcades, large entrances, shop fronts and buildings near the sea. Insulated slats are recommended for temperature controlled applications (such as cool rooms), where reduced heating or cooling transfer is required.

FEATURES

- Interlocking aluminium slats
- Strong design
- Insulation or Non-insulation option

DOOR DIMENSIONS

- Maximum Height: 4200mm*
- Maximum Width: 9000mm*

*Total door size shall not exceed 30m².

NOTE: Size restrictions may occur for external applications, consult manufacturer for details.

RECOMMENDED SPECIFICATIONS

Supa Slat Insulated or Supa Slat Non-Insulated aluminium roller shutter with 105mm high slats in 1.6mm thick material as manufactured by Airport Doors. The Roller Shutter operates by means of a flexible curtain made of interlocking aluminium slats winding onto an overhead drum and guided in aluminium door guides.

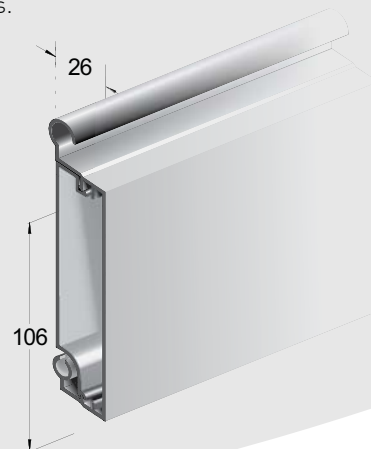

© Copyright 2015 Czapp Pty Ltd trading as Airport Doors. In line with Airport Doors' research and development program, Airport Doors reserves the right to change specifications at any time without notice.

Supa Slat Insulated/ Supa Slat Non-Insulated

Aluminium Roller Shutters

CURTAIN

The Supa Slat flat-finish curtain is manufactured from 105mm high by 30mm deep by 1.6mm thick specially extruded interlocking aluminium slats. The curtain of the Insulated version also comprises polystyrene infill with an aluminium or PVC backing plate to provide thermal insulation.

Alternating slats are fitted with nylon end clips to prevent lateral movement of the curtain and to ensure smooth operation.

FINISH

Aluminium slats are available in natural anodised as standard and can be colour anodised or powder coated when specified.

BOTTOM RAIL

The bottom rail is manufactured from extruded aluminium (of 165mm in height) and is fitted with a PVC bottom weather-seal. The bottom rail is attached to the bottom slat for adequate strengthening of the curtain.

DOOR GUIDES

The door guides are manufactured from 4mm thick specially extruded 133mm by 48mm aluminium sections. A felt cushioning seal is inserted into the door guide to facilitate smooth operation.

DRUM & SPRING ASSEMBLY

The drum consists of a seamless or spiral welded, cylindrical tube revolving around a central steel axle and encasing helical torsion springs matched to suit door size and weight. The springs are rolled from high grade spring wire and tempered. The drum is designed to provide minimal deflection over the door width.

DRUM SUPPORT BRACKETS

Supa Slat Roller Shutter drum support brackets are manufactured from mild steel plate with a minimum thickness of 8mm.

FIXING REQUIREMENTS

The building construction (typically steel or concrete) must be structurally sound and have adequate strength to support the Roller Shutter and its fixing requirements. Consult manufacturer for further details.

LOCKING

Chain operated Supa Slat Roller Shutters are fitted with a steel chain lock designed to accommodate a padlock. As an optional extra, chain operated shutters can also be fitted with two shoot-bolts. Shoot-bolts are fitted internally to each end of the bottom rail. Padlocks not included.

Electric operated (motorised) doors are secured by the motor and its controls.

NOTE: If optional shoot-bolts are fitted to a motorised shutter, a cut out switch for each shoot-bolt must be fitted.

MULLIONS (OPTIONAL)

Centre door mullions can be used for wide openings to create multiple door installations. Removable and sliding type mullions are manufactured from steel or aluminium of approximately 300mm width. A removable mullion, which allows the mullion to be removed by hand, is suitable up to 2.4m high. A sliding mullion is manually operated by disengaging top and bottom latches and sliding to one side of the doorway on an overhead sliding track fixed to the underside of the lintel. A fixed type mullion (typically made of steel) is not removable and is fixed to the floor and lintel.

OPERATION

Supa Slat Roller Shutters operate by means of a flexible interlocking aluminium curtain, winding onto an overhead drum and guided in aluminium door guides. They are installed to the inside face of an opening and overlap the nibs and lintel ('behind-fix'). Supa Slat Roller Shutters are available in chain operation or electric operation.

CHAIN OPERATION

Gearing is fitted to one end of the Roller Shutter and matched to suit the door size and weight. The curtain is opened and closed by hand chain via a reduction gear mechanism.

NOTE: Chain operation is not recommended for Supa Slat Roller Shutters over 20m².

MOTORISATION

Motorisation is via a geared electric motor and incorporates a standard reversing starter push-button station (control box) and emergency hand chain operation (in case of a power outage). The standard push-button station offers 'Up', 'Down' and 'Stop' functions.

Operator selection is dependent on the door size, door weight, wind loading, availability of power and the door's application. Motorisation is available in three-phase (415v) as standard, or single-phase (240v) power.

The provision of adequate mains power supply and isolator or GPO (as required) to motor location is the responsibility of the client. Wiring from the isolator and commissioning of the door, motor controllers and any ancillary hardware is by client, unless otherwise stated in writing.

Optional extras, such as high cycle motorisation, battery back-up and access control accessories are available upon specification.

For further information see Door Operators & Accessories.

OPTIONS

- Insulated/Non Insulated
- Tapered bottom
- Mullions

Supa Slat Insulated/Non-Insulated

Technical Specs: Aluminium Roller Shutters

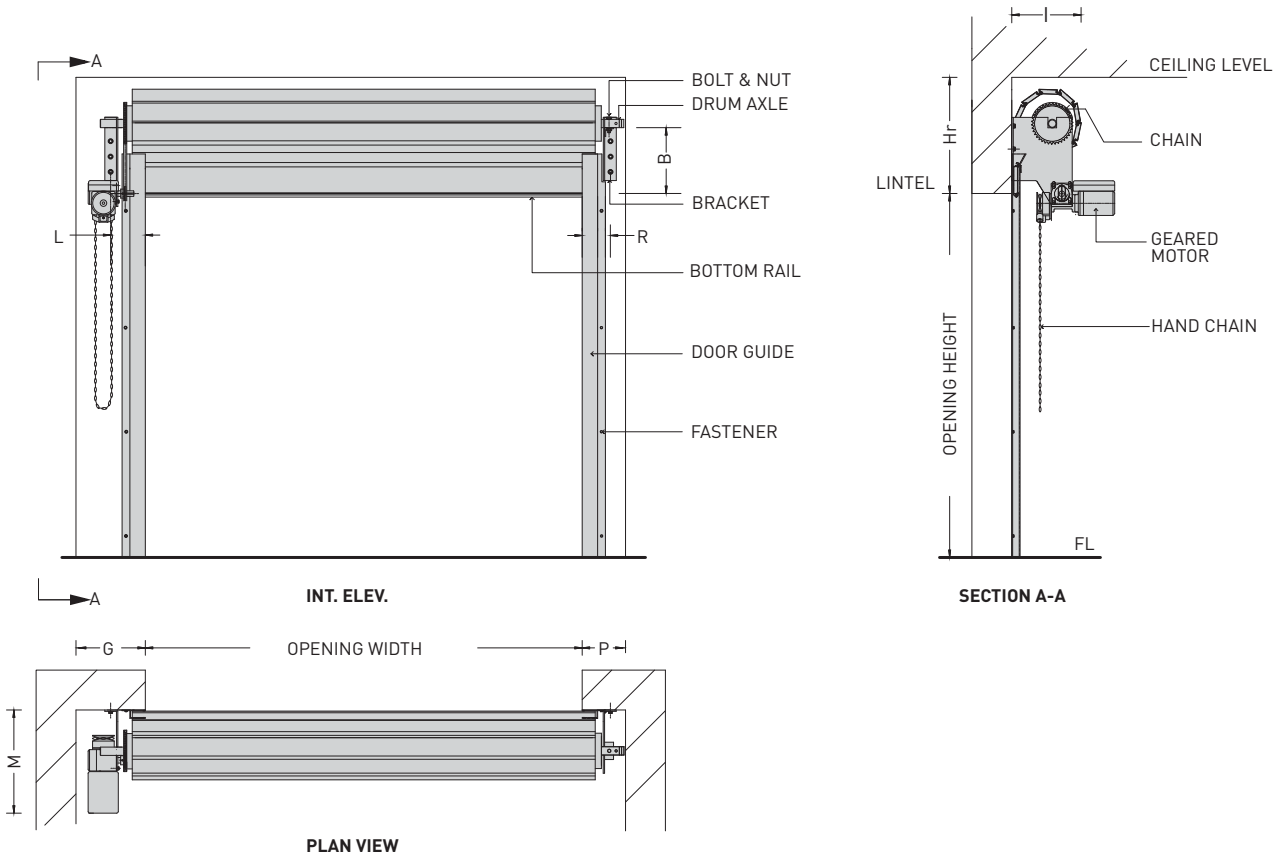

CLEARANCE DETAILS

HEIGHT UP TO	WIDTH UP TO 9m				OPERATION	DRIVEN END		PLAIN END	
	Hr	B	I	M		G	L	P	R
2100	670	400	490	595	HAND OPERATION	300	190	250	170
3000	720	450	530	595	MOTORISATION (STD)	500	190	250	170
3600	750	480	560	595	MOTORISATION (INBOARD*)	250	180	250	170
4200	770	485	580	595					

Notes:

- Standard chain operated or motorised doors have the drive unit fitted outboard.
- *Inboard motorisation is available when sufficient clearance is not available for standard motorisation. If fitted inboard, the drive unit fits partly within opening under drum/curtain. Add 150 to dimension M for inboard motorised doors.
- Door-stops on door guides are fitted on chain-operated shutters.
- Total door size must not exceed 30m².

Door Guides

Technical Specs: Aluminium Roller Shutters

SERIES 25 STANDARD DOOR GUIDES

BEHIND WALL FIXING

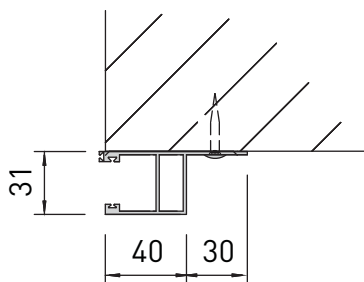

Aluminium Guide

BETWEEN WALL FIXING

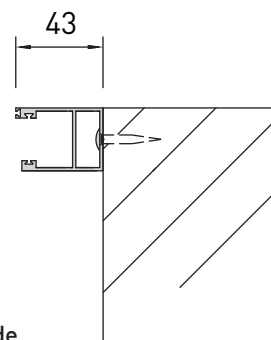

Aluminium Guide

SERIES 63 & CLEARLITE STANDARD DOOR GUIDES

BEHIND WALL FIXING

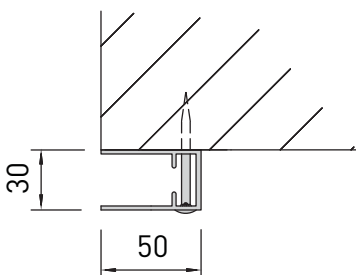

Aluminium Guide

BETWEEN WALL FIXING

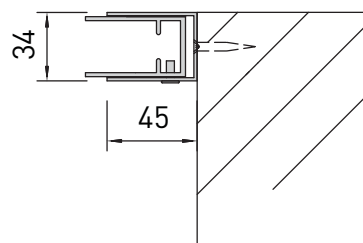

Aluminium Guide With Take Up Channel

PANORAMA STANDARD DOOR GUIDE

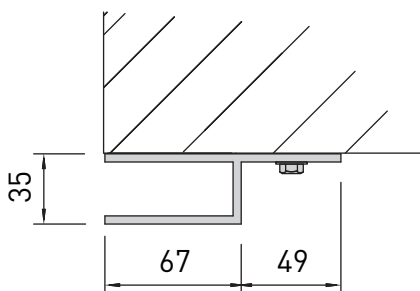

SUPA SLAT INSULATED & NON INSULATED STANDARD DOOR GUIDE

